



MICROCHIP



**Microchip Total System Solution
in Automotive Interior Lighting**

Challenge

- **RGB Lighting complex in manufacturing**
- **Innovation together with Lighting concept has been a challenging domain**



💡 **ISELED® and Microchip is solving the issue bringing ease of manufacturing and innovation together**

Why ISELED and Microchip?

- **ISELED makes LED lighting easier:**

- Colour temperature compensation
- LEDs aging
- LED integration

- **Microchip's solution offers:**

- Optimum selection of the MCU most suitable for the application
- Enables client's adding dynamic lighting effects with innovation

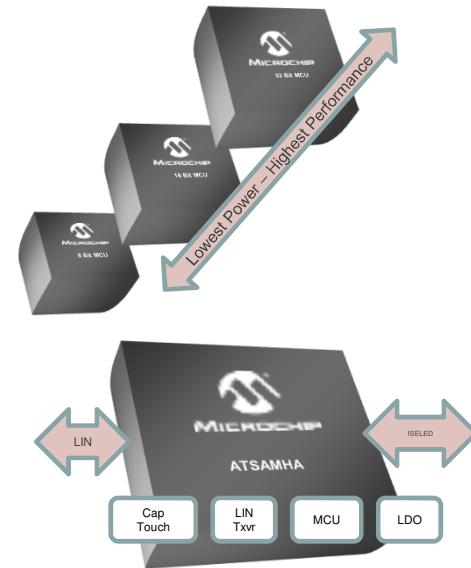



Application – Integration - Manufacturing



Suited based on End Application

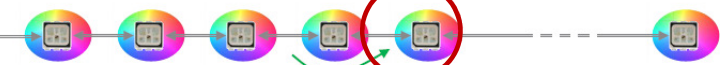
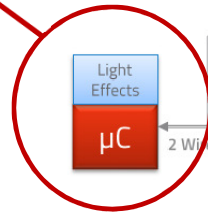
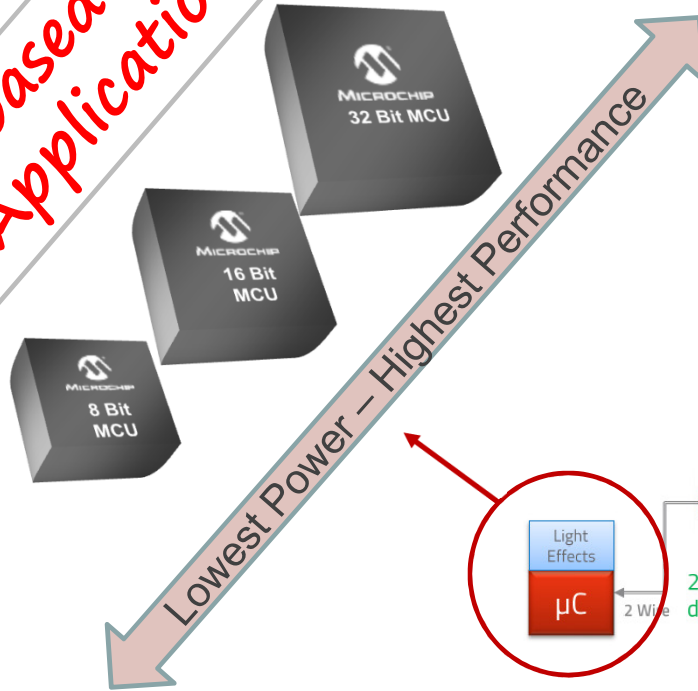

2 MBit/s differential; no clock

$T_{pd} = 2$ clock cycles
data nearly simultaneously at all LEDs
LEDs can be addressed individually

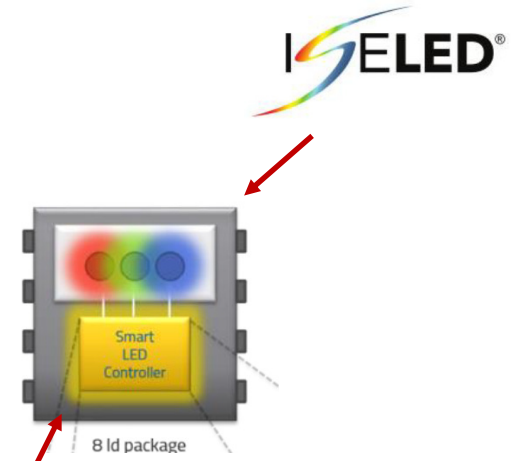

ISELED – Core Independence

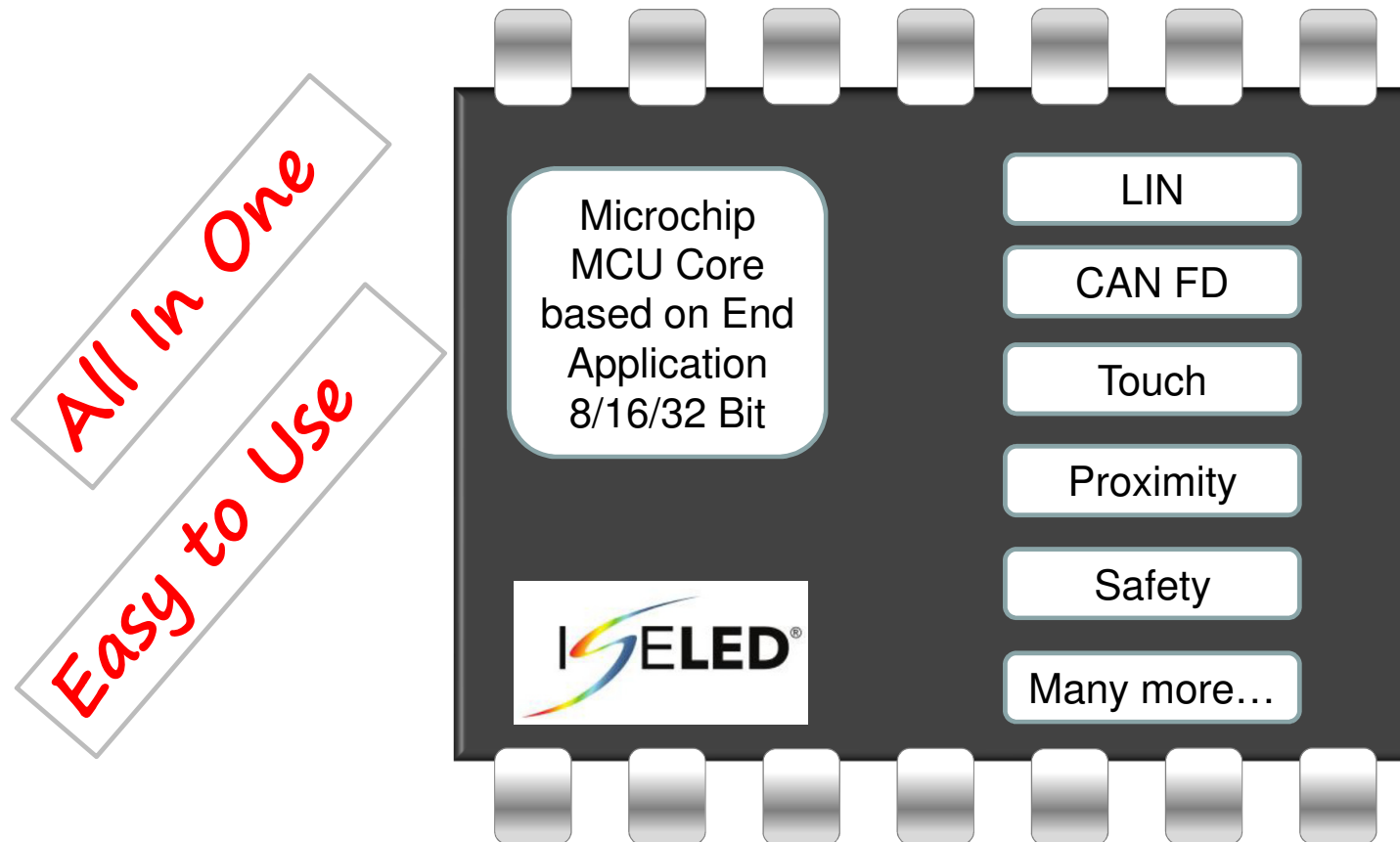

Total System Solution

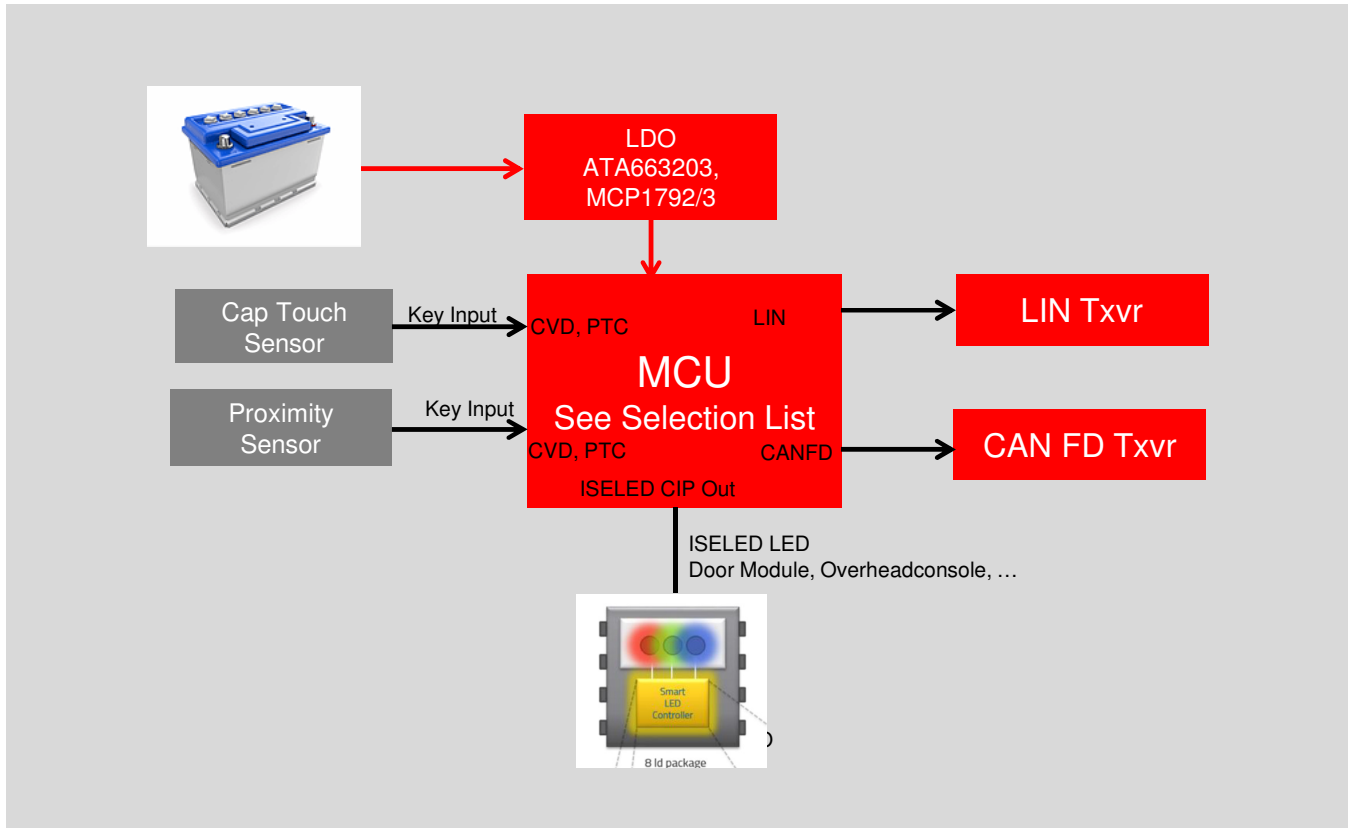



Supported ISELED Microcontrollers

8 Bit Microcontroller

- PIC16F153xx
- PIC16F188xx
- PIC18FxxK42
- PIC18FxxK83
- and more

16 Bit Microcontroller

- PIC24FJxxxGA70x
- dsPIC33EP128GS706
- dsPIC33EV256GM106
- dsPIC33EV256GM102
- and more

32 Bit Microcontroller

- PIC32MZ2048EFH100
- ATSAMHA1*
- ATSAMDA1
- ATSAMD21
- ATSAMC21
- and more





ISELED® Development Made Easy

- **MPLAB Code Configurator – ISELED CIP per Mouse Click**
- **End Application together with ISELED as easy as possible**
- **Development Tools Demoboard as Easy Click On Option, GUI, App Note, Library, Video**

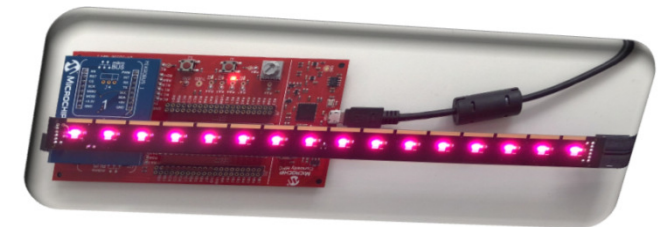
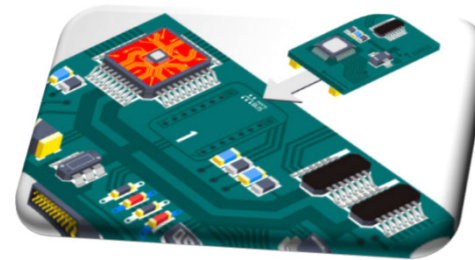



Evaluation License

- **Free Evaluation License**
- **Free of Charge**
- **Enables usage of Free Evaluation ISELED Framework**
- **Planned as a Download on the ISELED Landing Page**
- **Available on Manual Request meanwhile**
- **Usage for 3 months limitation but extension possible**
- **Limitations on functionality**

Summary

- **Enabling Innovation**

- Low System Costs & Low Investment Costs

- **ISELED value added Solutions**

- Highly integrated functions on Micro and System Level

- **Widest Automotive Micro Portfolio per Click ISELED capable**

- Solutions from 8-bit to 32-bit Micro
- Low risk, low cost, fast time to market development

